





























**AGIS M-AIR3**  
**AGIS M-AIR4**





|   |                                |    |
|---|--------------------------------|----|
|  | Preparation                    | 10 |
|  | Folding and unfolding          | 14 |
|  | Using the bumper bar           | 15 |
|  | Using the harness system       | 16 |
|  | Using the XXL sun canopy       | 20 |
|  | Adjusting the seating position | 21 |







|   |   |    |
|---|---|----|
|  | Using the brake                             | 22 |
|  | Using the swivel locks                      | 23 |
|  | Removing the wheels                         | 24 |
|  | Attaching the infant car seat and carry cot | 26 |
|  | Removing the seat cover                     | 30 |

|   |                                 |    |
|---|---------------------------------|----|
|  | Vorbereitung                    | 10 |
|  | Zusammen- und Auseinanderfalten | 14 |
|  | Verwendung des Schutzbügels     | 15 |
|  | Verwendung des Gurtsystems      | 16 |
|  | Verwendung des XXL Sonnendachs  | 20 |
|  | Einstellen der Sitzposition     | 21 |





|   |  |    |
|---|--|----|
|  | Benutzung der Bremse                                   | 22 |
|  | Arretieren der Vorderräder                             | 23 |
|  | Entfernen der Räder                                    | 24 |
|  | Anbringung der Babyschale und des Kinderwagenaufsatzes | 26 |
|  | Abnehmen des Sitzbezuges                               | 30 |

|   |                                      |    |
|---|--------------------------------------|----|
|  | Préparation                          | 10 |
|  | Pliage et dépliage                   | 14 |
|  | Utilisation du garde-corps           | 15 |
|  | Utilisation du harnais               | 16 |
|  | Utilisation du canopy parasoleil XXL | 20 |
|  | Réglage de la position d'assise      | 21 |

|   |                                       |    |
|---|---------------------------------------|----|
|  | Utilisation du frein                  | 22 |
|  | Utilisation du verrou de rotation     | 23 |
|  | Retrait des roues                     | 24 |
|  | Fixation de la coque et de la nacelle | 26 |
|  | Retrait de la housse                  | 30 |

|   |                                   |    |
|---|-----------------------------------|----|
|  | Preparación                       | 10 |
|  | Plegado y desplegado              | 14 |
|  | Uso de la barra apoyabrazos       | 15 |
|  | Uso del sistema de arneses        | 16 |
|  | Uso de la capota solar XXL        | 20 |
|  | Ajuste de la posición del asiento | 21 |



|   |  |    |
|---|--|----|
|  | Uso del freno                                      | 22 |
|  | Uso del bloqueo de dirección                       | 23 |
|  | Extracción de las ruedas                           | 24 |
|  | Colocar la silla de seguridad infantil y el capazo | 26 |
|  | Extracción de la vestidura del asiento             | 30 |

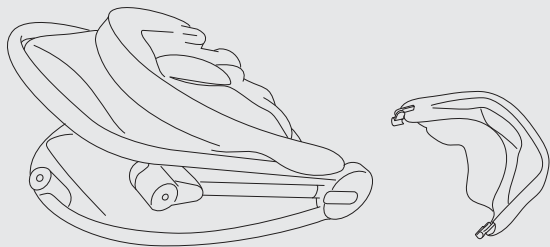

**OPTIONAL**

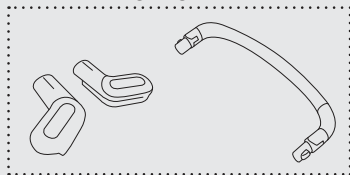

## AGIS M-AIR3

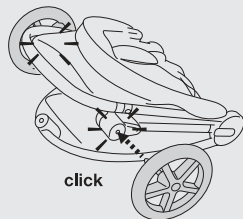

2

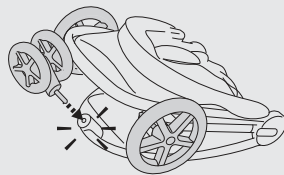

3

## AGIS M-AIR4

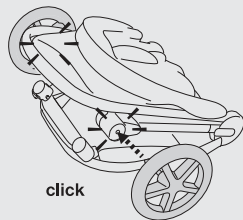

2

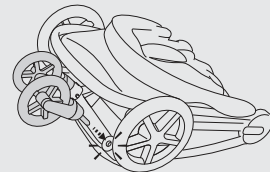

3

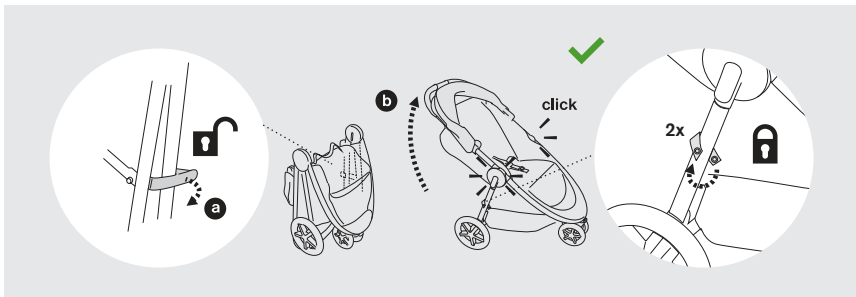

4

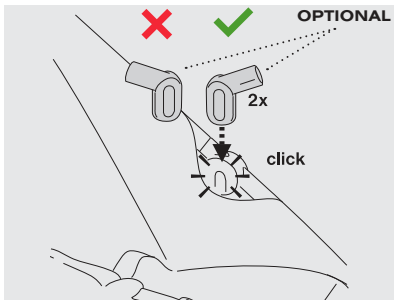

5

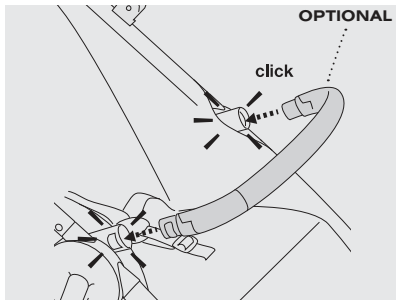

6

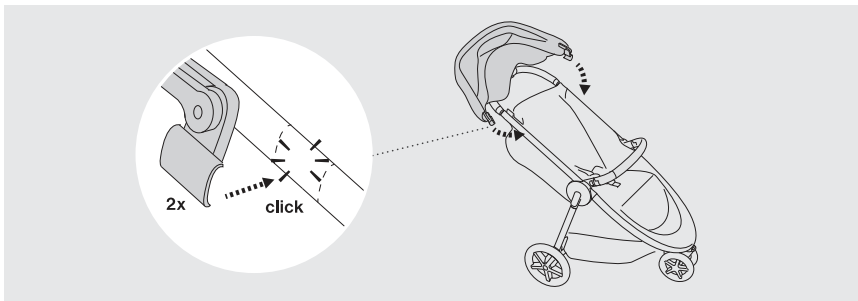

7

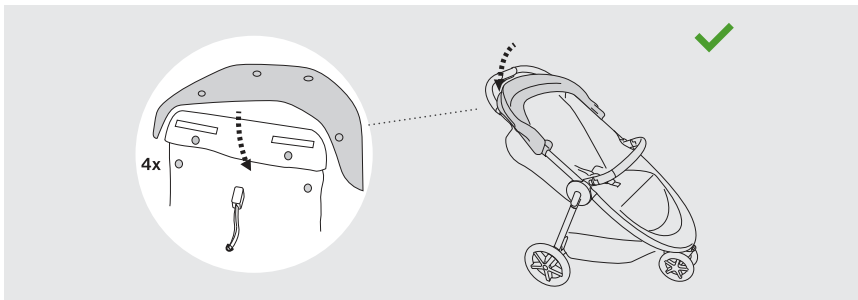

8

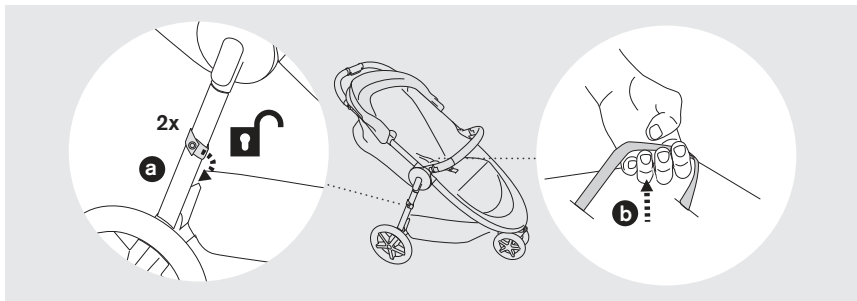

1

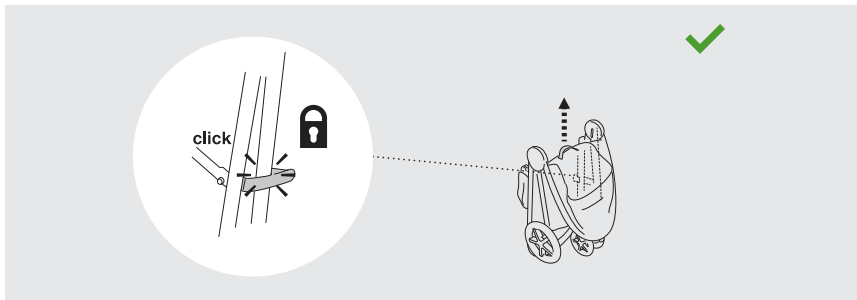

2

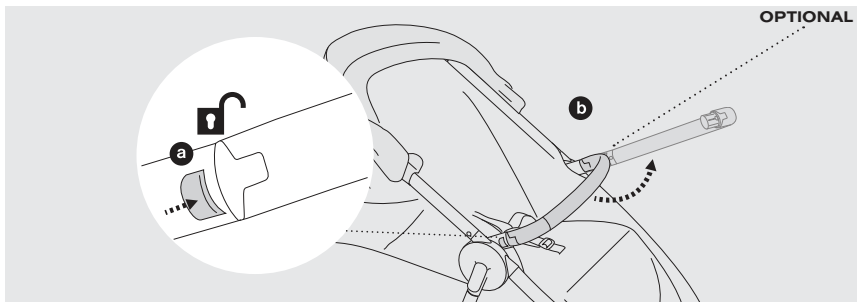

1

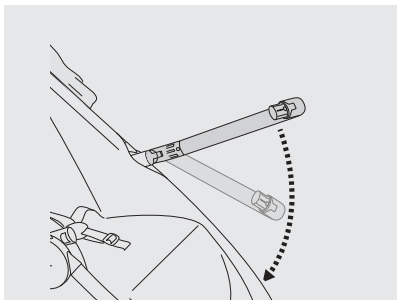

2

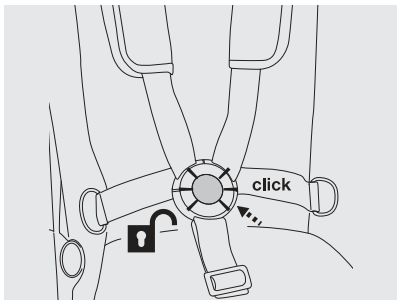

1

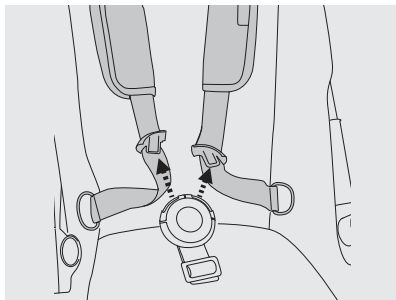

2

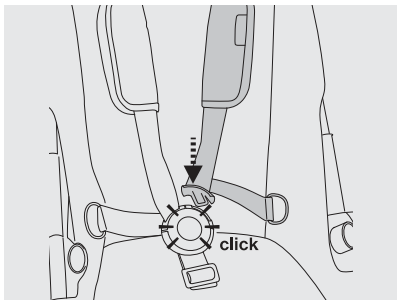

3

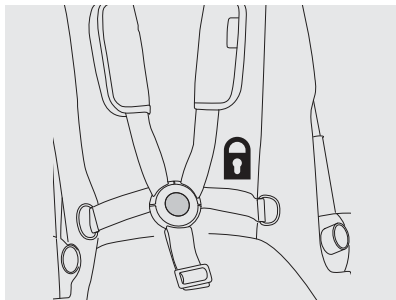

4



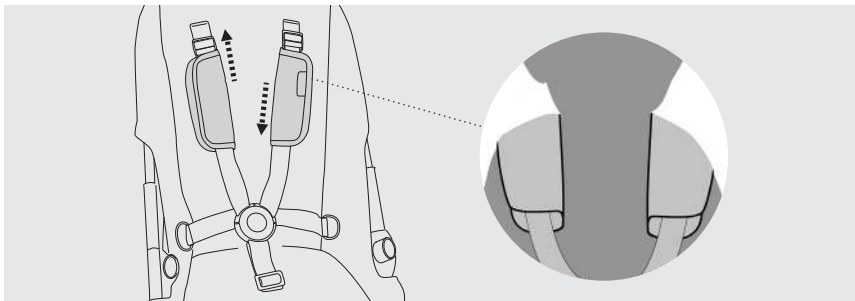

1

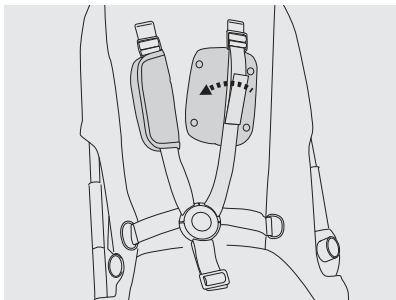

2

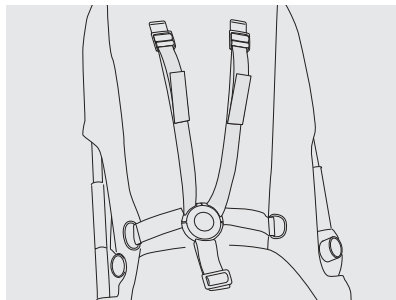

3

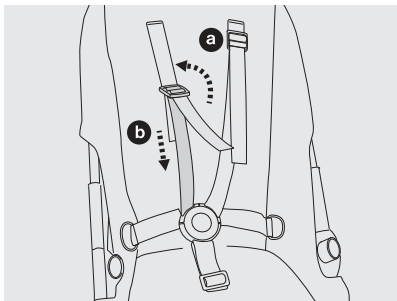

4

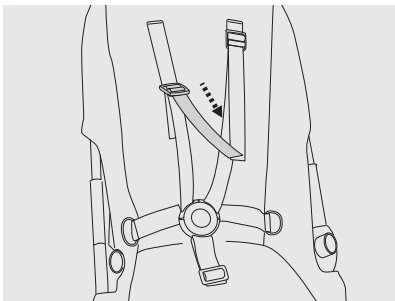

5

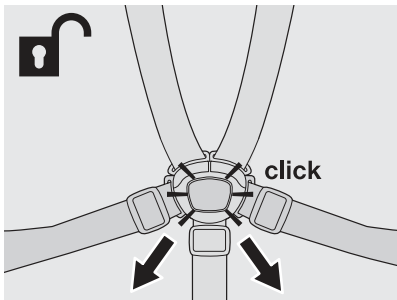

1

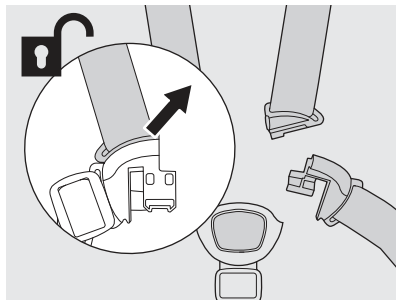

2

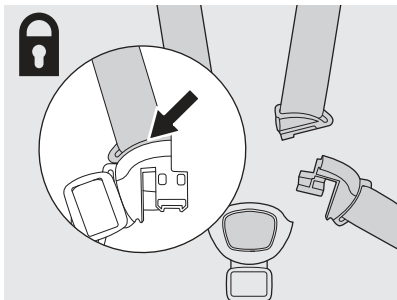

3

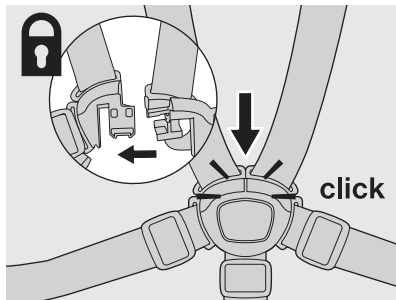

4





1

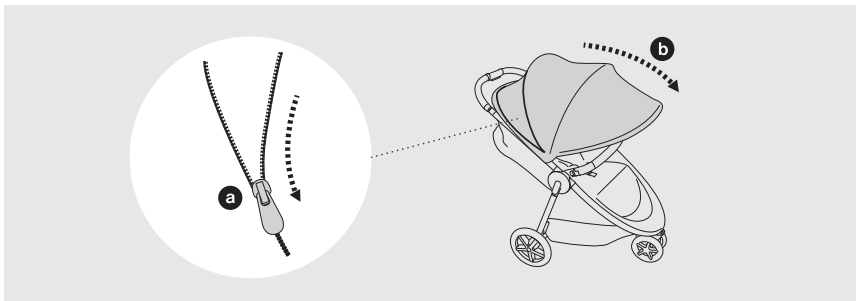

2

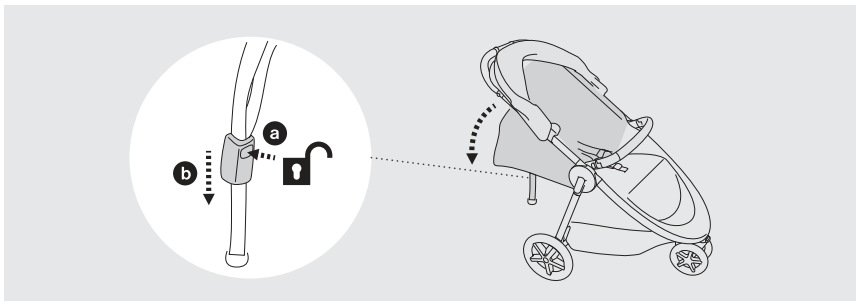

1

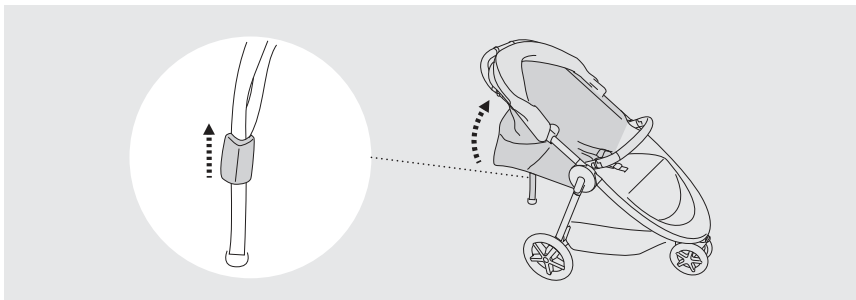

2

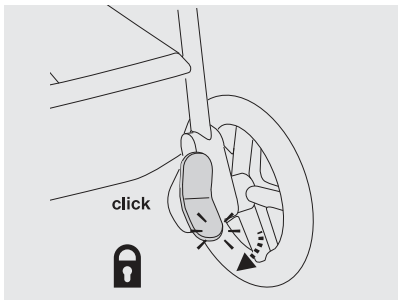

1

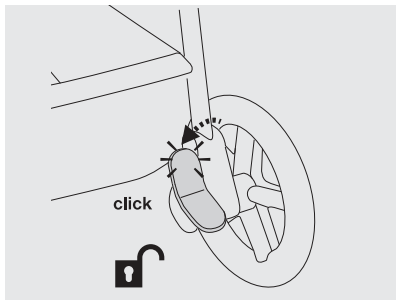

2

### AGIS M-AIR3

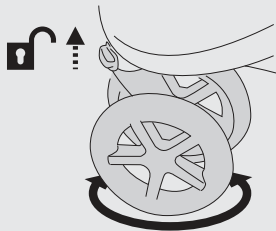

1

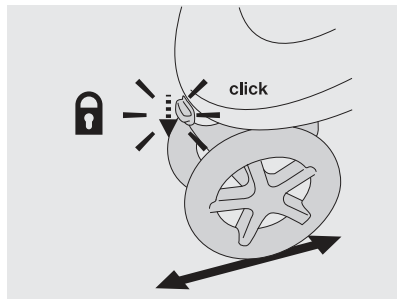

2



### AGIS M-AIR4

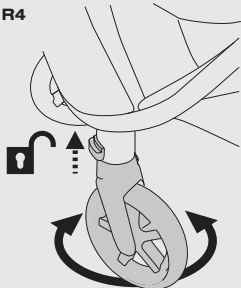

1

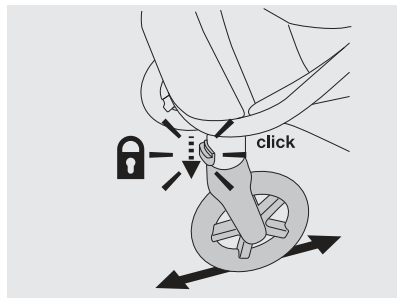

2



## AGIS M-AIR3

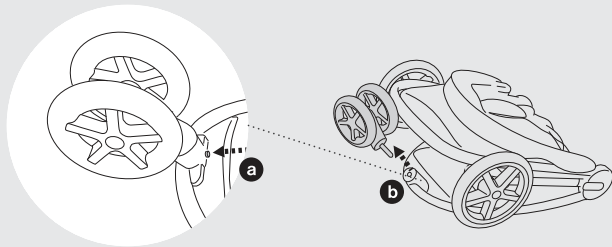

1

## AGIS M-AIR4

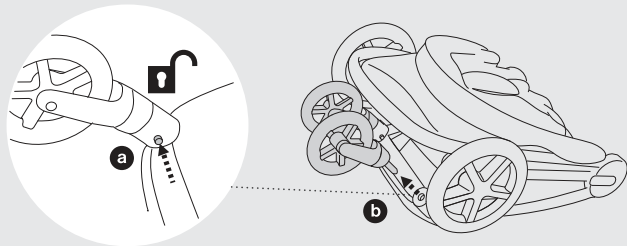

1



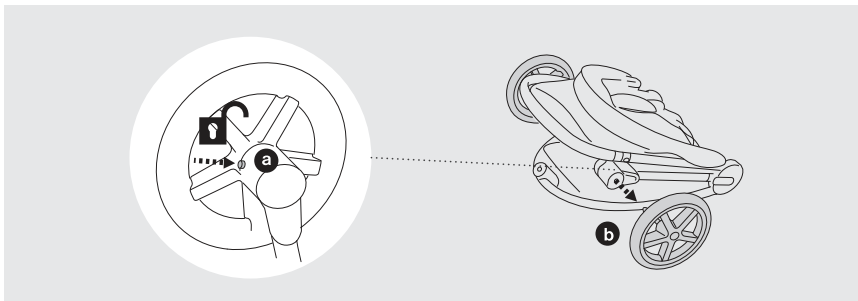

2

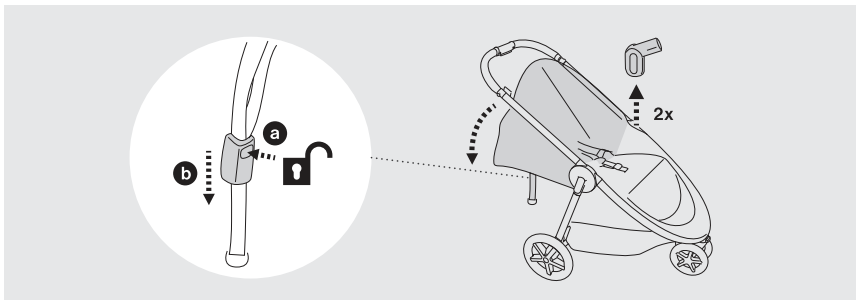

1

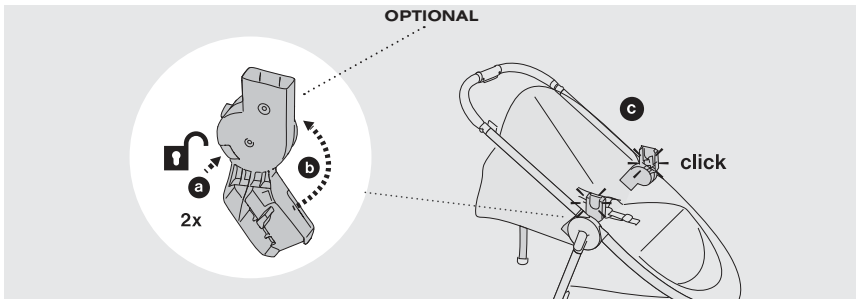

2

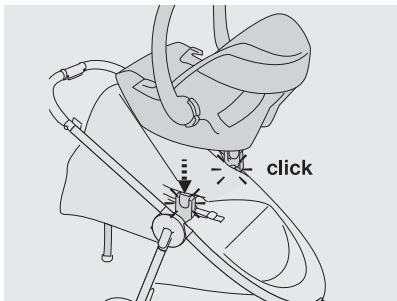

3

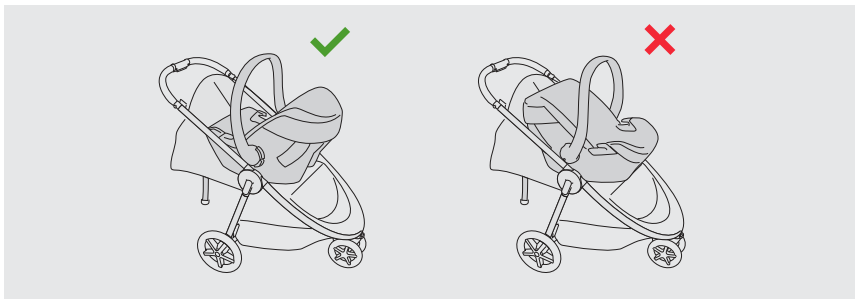

4

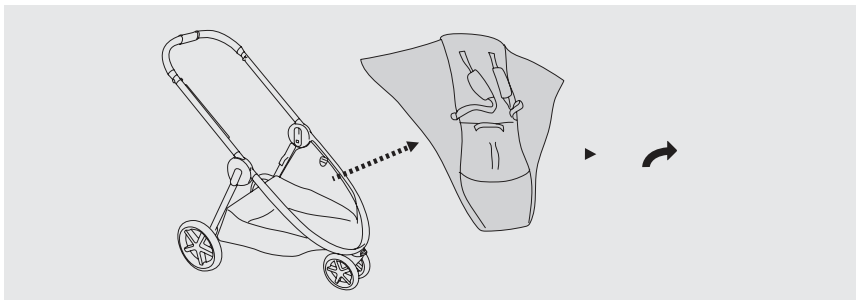

1

1

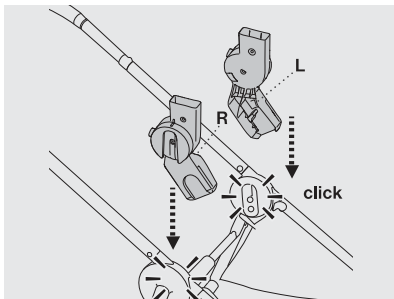

2

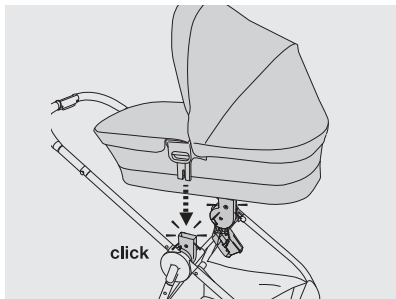

3

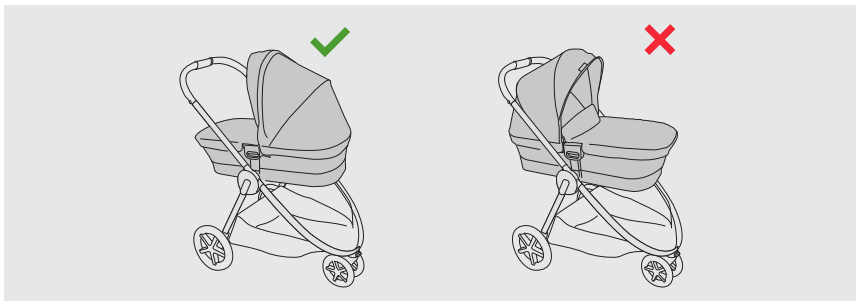

4

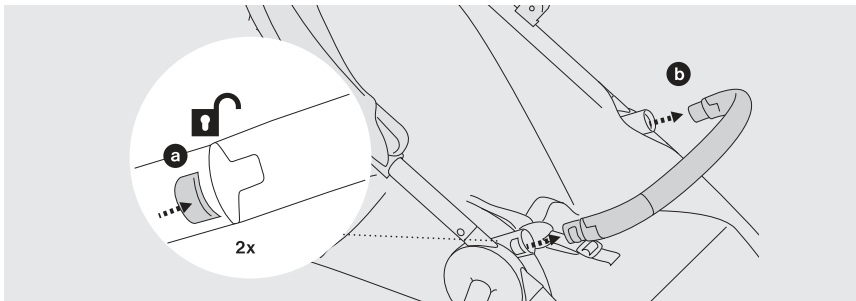

1

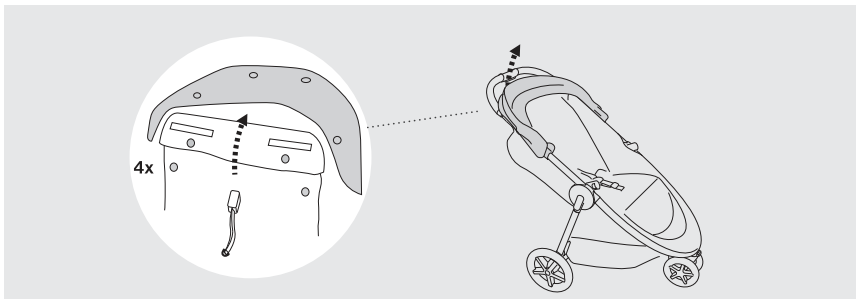

2

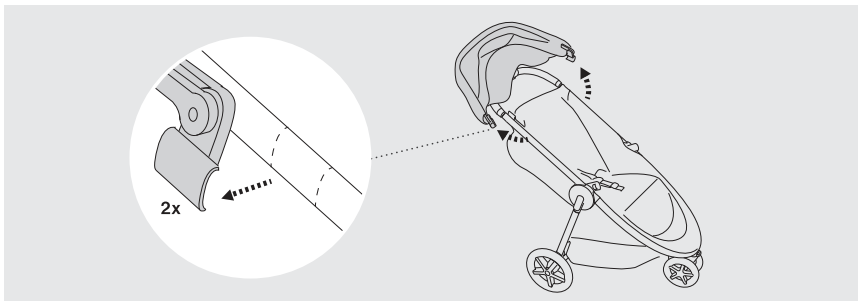

3

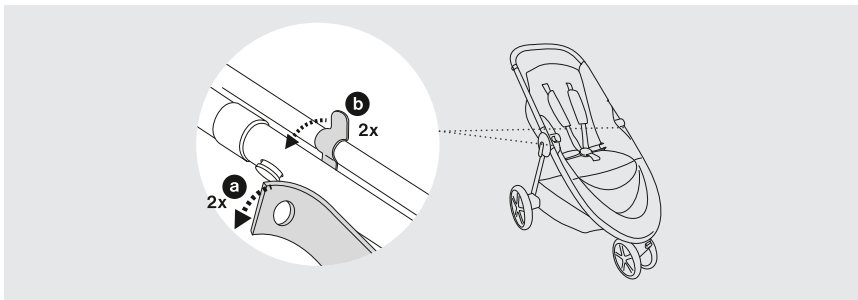

4



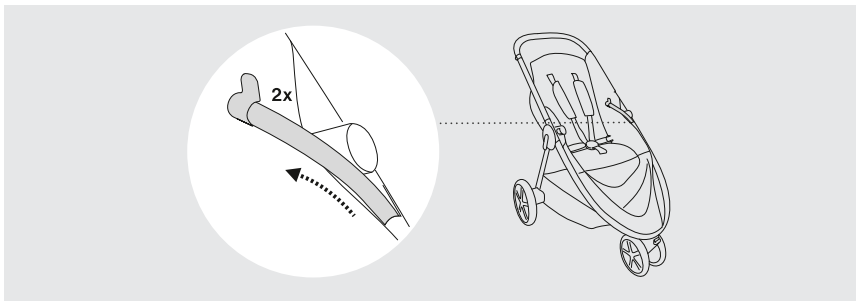

5

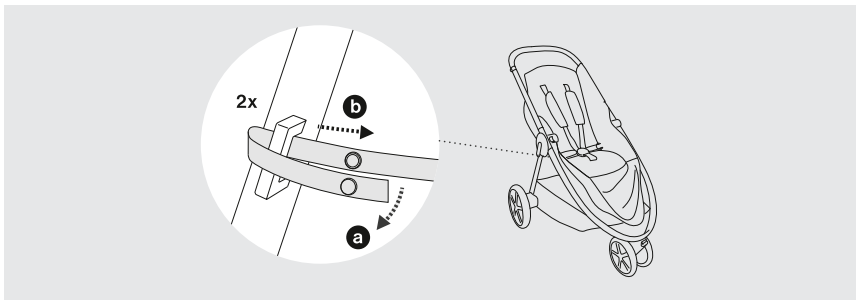

6



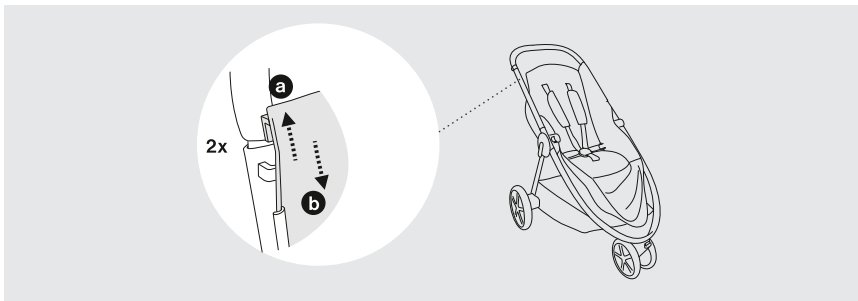

7

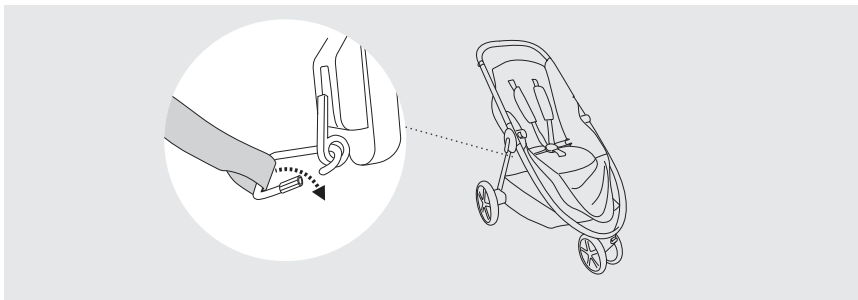

8



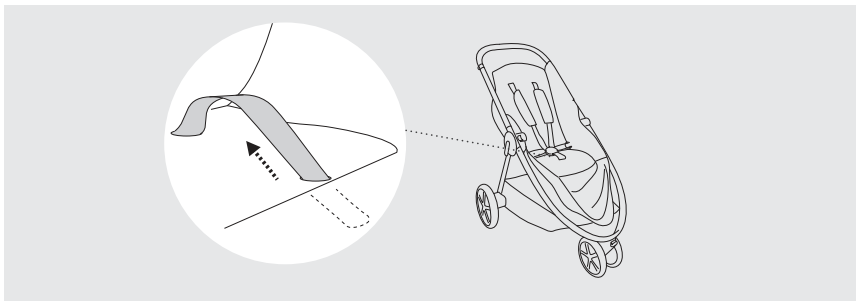

9

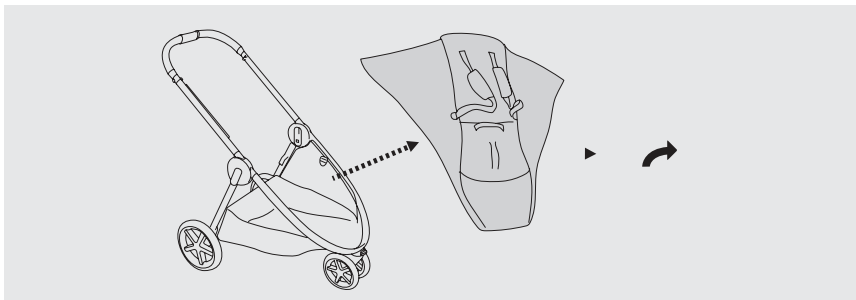

10

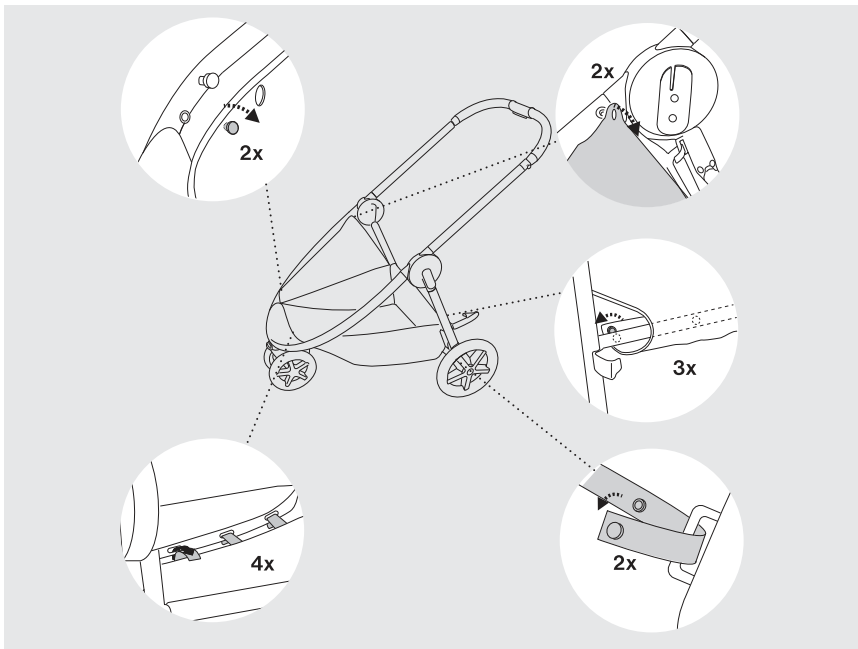

## CONTACT

### Europe

CYBEX GmbH  
Riedingerstr. 18  
95448 Bayreuth  
Germany  
+49 (0) 921-78 511 - 0  
info@cybex-online.com

### Americas

Columbus Trading-Partners USA Inc.  
560 Harrison Avenue, Suite 500  
Boston, MA 02118, USA  
Customer Service 1-877-242-5676  
orders.us@columbustp.com

### Japan

Cybex Industrial Ltd.  
Room 2001, 20/F  
Two Chinachem Exchange Square  
338 King's Road, North Point, Hong Kong  
+81 30 5456 5225  
info@cybex-japan.com

### Australia

CNP Brands  
20 Calarco Drive, VIC, 3030  
Australia  
Customer Service 1300 667 137  
info@cnpbrands.com.au

### New Zealand

Wainhouse Distribution,  
2-6 Argyle St, Morningside, PO Box 41-014,  
St Lukes, Auckland, New Zealand  
Customer Service 0800 567 5000  
helpline@wainhousedist.co.nz



[www.cybex-online.com](http://www.cybex-online.com)